MIC 1801

1/8 DIN MICROBASED LIMIT CONTROLLER

OPERATORS
MANUAL
FORM 3607
EDITION 1
© JUNE 1995
PRICE \$10.00



CIRCULAR CHART RECORDERS • STRIP CHART RECORDERS • DATA ACQUISITION SYSTEMS
DATALOGGERS • ANALOG AND MICROBASED CONTROLLERS
MECHANICAL RECORDERS AND CONTROLLERS

PARTLOW CORPORATION • 2 CAMPION ROAD • NEW HARTFORD, NY 13413 USA
1-800-866-6659 • 315-797-2222 • FAX 315-797-0403

Information in this installation, wiring, and operation manual is subject to change without notice. One manual is provided with each instrument at the time of shipment. Extra copies are available at the price published on the front cover.

Copyright © June 1995, The Partlow Corporation, all rights reserved. No part of this publication may be reproduced, transmitted, transcribed or stored in a retrieval system, or translated into any language in any form by any means without the written permission of the Partlow Corporation.

This is the First Edition of the MIC 1801 manual. It was written and produced entirely on a desk-top-publishing system. Disk versions are available by written request to the Partlow Publications Department.

We are glad you decided to open this manual. It is written so that you can take full advantage of the features of your new MIC 1801 limit controller.

Table of Contents

Section 1 - General	Page
1.1 Product Description	5
Section 2 - Installation & Wiring	
2.1 Installation & Wiring	7
2.2 Preparations for Wiring	9
2.3 Input Connections	15
2.4 Output Connections	17
Section 3 - Configuration & Operation	
3.1 Operation	19
3.2 Configuration	24
Appendices	
A - Glossary of Terms	30
B - Exploded View & Board Layout	34
Figure B-1 Exploded View	34
Figure B-2 Output 2/Output 3 Removal	35
Figure B-3 CPU PWA	36
Figure B-4 Option PWA DC Output 3	37
C - Hardware Definition Code	48
D - Input Range Codes	40
E - Specifications	42
F - Model Number Hardware Matrix	46
G - Software Reference Sheet	47

Figures & Tables

Figure 1-1	Display Illustration	6
Figure 2-1	Panel Cut-Out Dimensions	8
Figure 2-2	Main Dimensions	8
Figure 2-3	Panel Mounting	9
Figure 2-4	Noise Suppression	12
Figure 2-5	Noise Suppression	12
Figure 2-6	Wiring	14
Figure 2-7	AC Power	15
Figure 2-8	Thermocouple Input	15
Figure 2-9	RTD Input	15
Figure 2-10	Volt, mV mADC Input	16
Figure 2-11	Remote Reset	16
Figure 2-12	Remote Digital Connections	17
Figure 2-13	Relay Output 1	17
Figure 2-14	Relay Output 2	17
Figure 2-15	Relay Output 3	18
Figure 2-16	mADC Output 3	18
Table 3-1	Enable Mode Configuration Procedures	25
Table 3-2	Program Mode Configuration Procedures	26
Table 3-3	Set-Up Mode Configuration Procedures	28

Product Description 1.1

1.1.1 GENERAL

This instrument is a microprocessor based single loop limit controller, user configurable to either High Limit type or Low Limit type.

The input is user configurable to directly connect to either thermocouple, RTD, mVDC, VDC or mADC inputs. The instrument can operate from a 90-264 VAC, 50/60 HZ power supply.

Features include fail safe operation (relay de-energized by the limit exceeded condition), front panel Reset switch, time limit exceeded display and maximum/minimum tracking of excursions of the process variable.

1.1.2 DISPLAYS

Each instrument is provided with dual displays and status indicators as shown in Figure 1-1. The upper display displays the value of the process variable. The lower display displays the setpoint value. Status indication is as shown in Figure 1-1, page 6.

1.1.3 ALARMS

Alarm indication is standard on all instruments. Up to two alarm outputs are possible. Alarm type may be set as Process Direct or Reverse (high or low), Logical Combination of the two alarms and Annunciator Direct or Reverse. Alarm status is indicated by LED.

1.1.4 PROCESS VARIABLE/SETPOINT VALUE RE-TRANSMISSION OUTPUT

If the instrument is specified with this option, this output may be scaled over any desired range and re-transmitted.

FIGURE 1-1
Keys and Indicators



Installation and Wiring 2.1

Electrical code requirements and safety standards should be observed and installation performed by qualified personnel.

The electronic components of the instrument may be removed from the housing during installation. To remove the components, grip the side edges of the front panel and pull the instrument forward. During re-installation, the vertically mounted circuit boards should be properly aligned in the housing.

Ensure that the instrument is correctly orientated. A stop will operate if an attempt is made to insert the instrument incorrectly. **CAUTION: This stop can be over-ridden with enough force. If in doubt, check orientation again!**

Recommended panel opening sizes are illustrated in Figure 2-1, page 8. After the opening is properly cut, insert the instrument into the panel opening. Ensure that the panel gasket is not distorted and that the instrument is positioned squarely against the panel. Slide the mounting clamp into place on the instrument (see Figure 2-3, page 9) and push it forward until it is firmly in contact with the rear face of the mounting panel.

Note: The mounting clamp tongues may engage either on the sides or the top/bottom of the instrument housing. Therefore, when installing several instruments side-by-side in one cut out, use the ratchets on the top/bottom faces.

FIGURE 2-1

Panel Cut-Out Dimensions

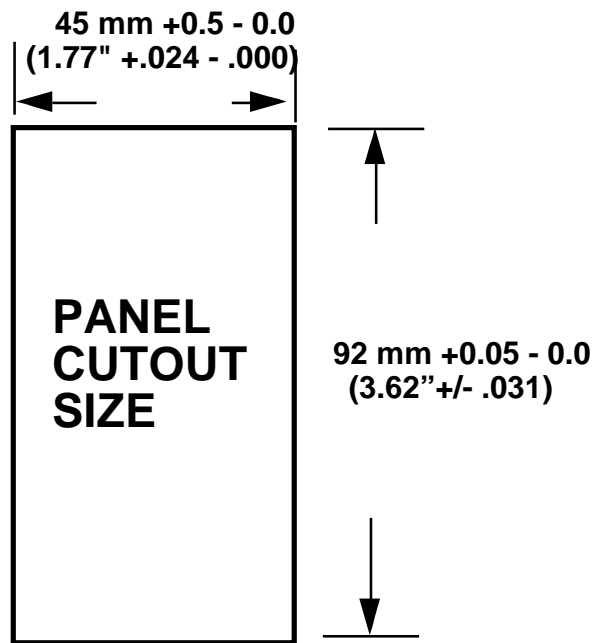

FIGURE 2-2

Main Dimensions

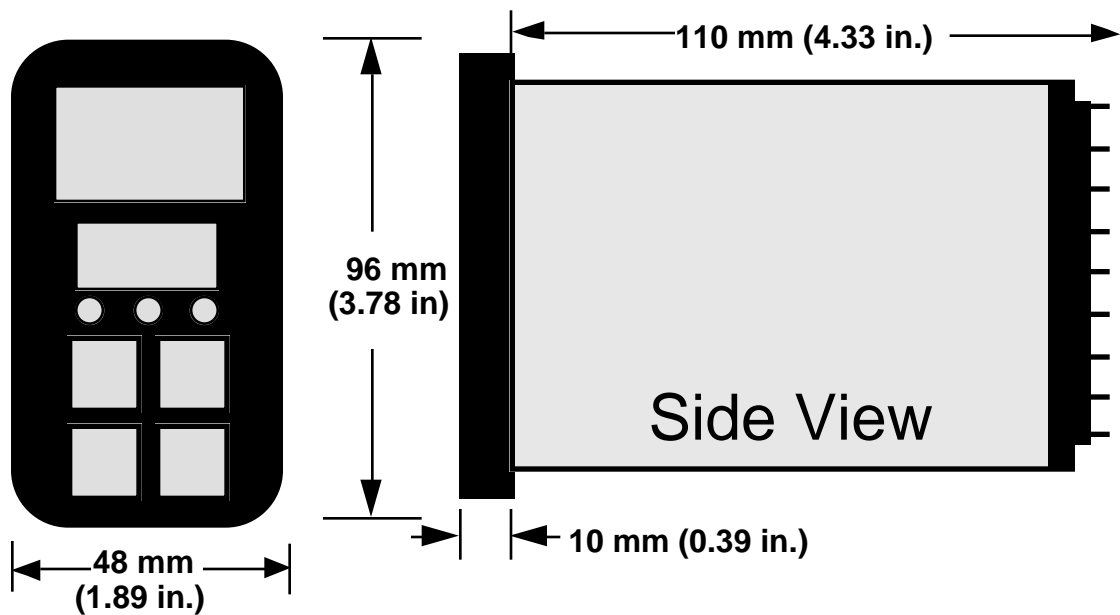
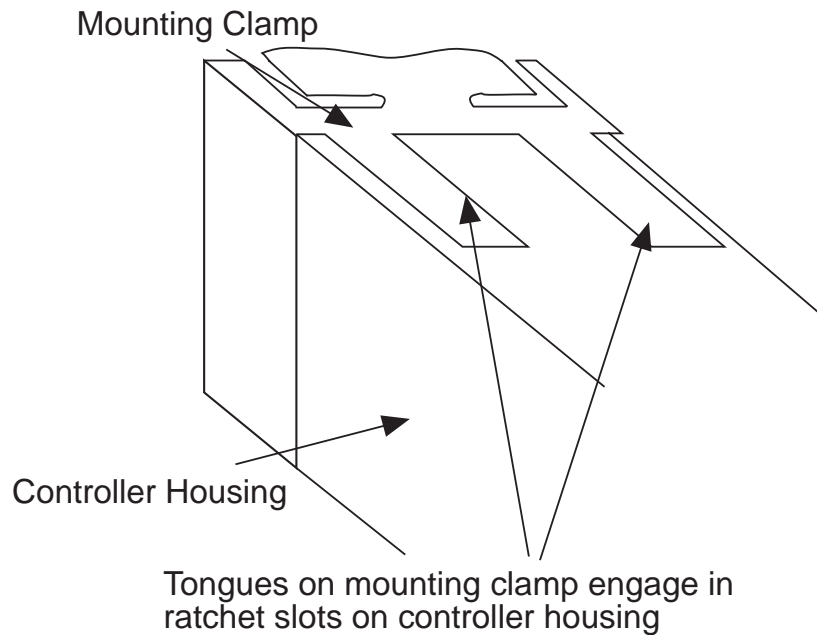

FIGURE 2-3

Panel Mounting the Controller



Preparation for Wiring 2.2

2.2.1 WIRING GUIDELINES

Electrical noise is a phenomenon typical of industrial environments. The following are guidelines that must be followed to minimize the effect of noise upon any instrumentation.

2.2.1.1 INSTALLATION CONSIDERATIONS

Listed below are some of the common sources of electrical noise in the industrial environment:

- Ignition Transformers
- Arc Welders
- Mechanical contact relay(s)
- Solenoids

Before using any instrument near the device listed, the instructions below should be followed:

1. If the instrument is to be mounted in the same panel as any of the listed devices, separate them by the largest distance possible. For maximum electrical noise reduction, the noise generating devices should be mounted in a separate enclosure.
2. If possible, eliminate mechanical contact relay(s) and replace with solid state relays. If a mechanical relay being powered by an instrument output device cannot be replaced, a solid state relay can be used to isolate the instrument.
3. A separate isolation transformer to feed only instrumentation should be considered. The transformer can isolate the instrument from noise found on the AC power input.
4. If the instrument is being installed on existing equipment, the wiring in the area should be checked to insure that good wiring practices have been followed.

2.2.1.2 AC POWER WIRING

Neutral (For 115 VAC)

It is good practice to assure that the AC neutral is at or near ground potential. To verify this, a voltmeter check between neutral and ground should be done. On the AC range, the reading should not be more than 50 millivolts. If it is greater than this amount, the secondary of this AC transformer supplying the instrument should be checked by an electrician. A proper neutral will help ensure maximum performance from the instrument.

2.2.1.3 WIRE ISOLATION

Four voltage levels of input and output wiring may be used with the unit:

- Analog input or output (i.e. thermocouple, RTD, VDC, mVDC, or mADC)
- SPDT Relays
- AC power

The only wires that should run together are those of the same category. If they need to be run parallel with any of the other lines, maintain a minimum 6 inch space between the wires. If wires must cross each other, do so at 90 degrees. This will minimize the contact with each other and reduces “cross talk”.

“Cross Talk” is due to the EMF (Electro Magnetic Flux) emitted by a wire as current passes through it. This EMF can be picked up by other wires running in the same bundle or conduit.

In applications where a High Voltage Transformer is used (i.e. ignition systems) the secondary of the transformer should be isolated from all other cables.

This instrument has been designed to operate in noisy environments, however, in some cases even with proper wiring it may be necessary to suppress the noise at its source.

2.2.1.4 USE OF SHIELDED CABLE

Shielded cable helps eliminate electrical noise being induced on the wires. All analog signals should be run with shielded cable. Connection lead length should be kept as short as possible, keeping the wires protected by the shielding. The shield should be grounded at one end only. The preferred grounding location is the sensor, transmitter or transducer.

2.2.1.5 NOISE SUPPRESSION AT THE SOURCE

Usually when good wiring practices are followed no further noise protection is necessary. Sometimes in severe electrical environments, the amount of noise is so great that it has to be suppressed at the source. Many manufacturers of relays, contactors, etc. supply “surge suppressors” which mount on the noise source.

For those devices that do not have surge suppressors supplied, RC (resistance-capacitance) networks and/or MOV (metal oxide varistors) may be added.

Inductive Coils - MOV's are recommended for transient suppression in inductive coils connected in parallel and as close as possible to the coil. See Figure 2-4, page 12. Additional protection may be provided by adding an RC network across the MOV.

FIGURE 2-4

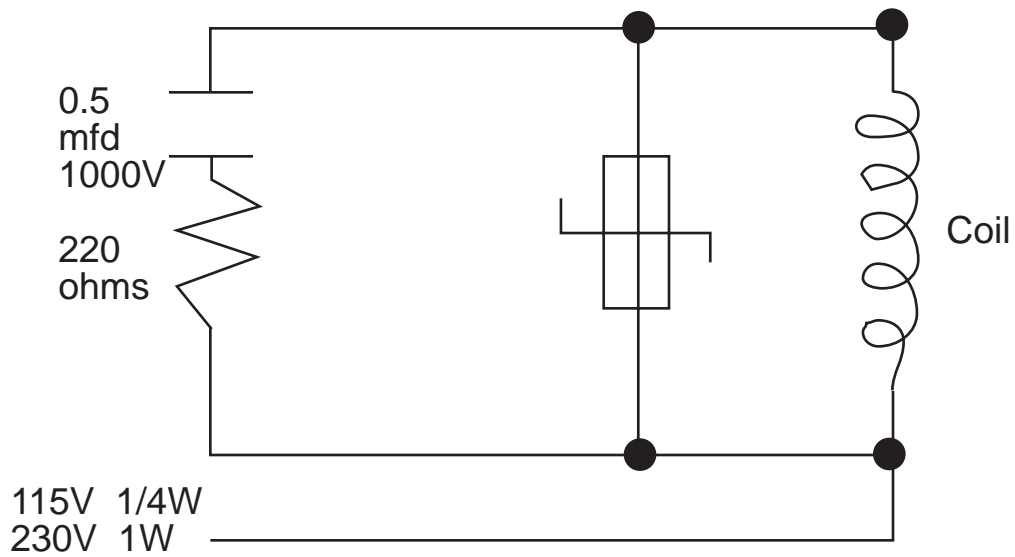

Contacts - Arcing may occur across contacts when the contact opens and closes. This results in electrical noise as well as damage to the contacts. Connecting a RC network properly sized can eliminate this arc.

For circuits up to 3 amps, a combination of a 47 ohm resistor and 0.1 microfarad capacitor (1000 volts) is recommended. For circuits from 3 to 5 amps, connect 2 of these in parallel. See Figure 2-5.

FIGURE 2-5

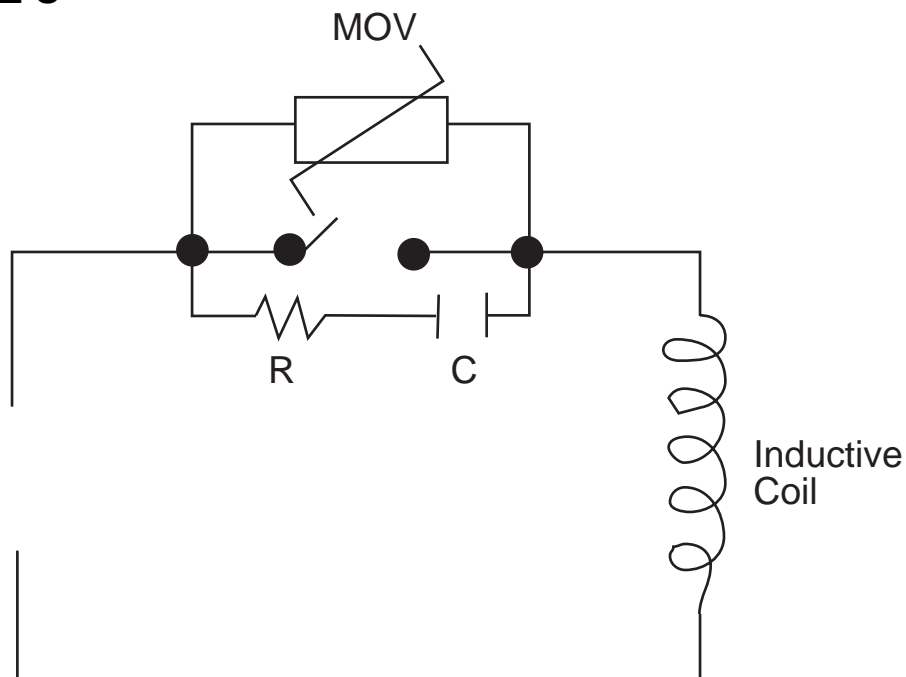

2.2.2 SENSOR PLACEMENT (Thermocouple or RTD)

Two wire RTD's should be used only with lead lengths less than 10 feet.

If the temperature probe is to be subjected to corrosive or abrasive conditions, it should be protected by the appropriate thermowell. The probe should be positioned to reflect true process temperature:

In liquid media - the most agitated area

In air - the best circulated area

FIGURE 2-6
Wiring Label

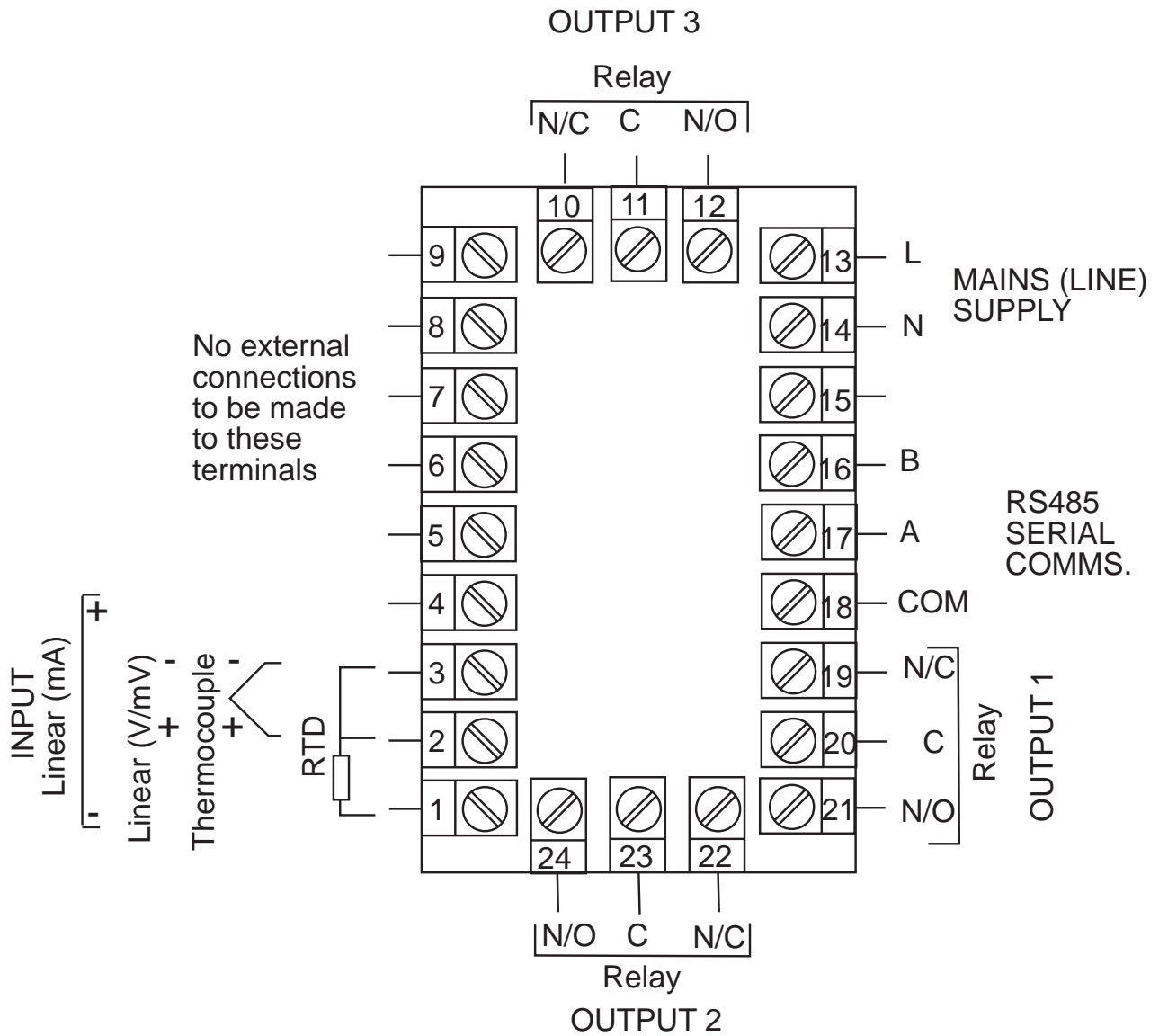

Input Connections 2.3

In general, all wiring connections are made to the instrument after it is installed. Avoid electrical shock. AC power wiring must not be connected to the source distribution panel until all wiring connection procedures are completed.

FIGURE 2-7

AC Power

Connect the line voltage, hot and neutral, to terminals 13 and 14 respectively as illustrated below.

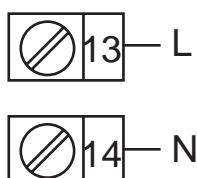

FIGURE 2-8

Thermocouple (T/C) Input

Make thermocouple connections as illustrated below. Connect the positive leg of the thermocouple to terminal 2 and the negative leg to terminal 3.

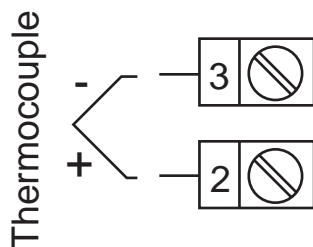

FIGURE 2-9

RTD Input

Make RTD connections as illustrated on page 16. For a three wire RTD, connect the resistive leg of the RTD to terminal 1 and the common legs to terminals 2 and 3. For a two wire RTD, connect one leg to terminal 2 and the other leg to terminal 1 as shown. A jumper wire supplied by the customer must be installed between terminals 3 and 2. Input conditioning jumper must be positioned correctly (see Appendix B) and Hardware Definition Code must be correct (see Appendix C).

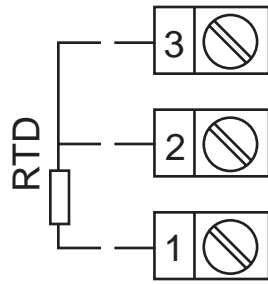

FIGURE 2-10

Volt, mV Input

Make volt and millivolt connections as shown below. Terminal 2 is positive and terminal 3 is negative. Input conditioning jumper must be positioned correctly (see Appendix B) and Hardware Definition Code must be correct (see Appendix C).

mADC Input

Make mADC connections as shown below. Terminal 3 is positive and terminal 1 is negative. Input conditioning jumper must be positioned correctly (see Appendix B) and Hardware Definition Code must be correct (see Appendix C).

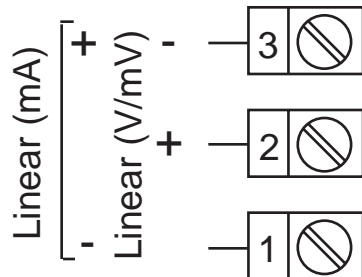

FIGURE 2-11

Remote Reset

Make connection as shown below.

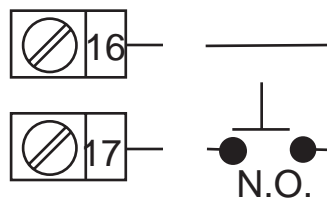
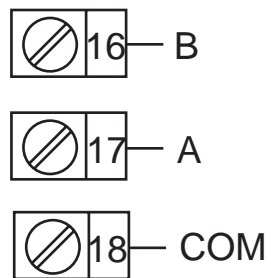

FIGURE 2-12

Remote Digital Communications - RS485

Make digital communication connections as illustrated below.



Output Connections 2.4

FIGURE 2-13

Relay Output 1

Connections are made to Output 1 relay as illustrated below. The contacts are rated at 5 amp resistive, 120/240 VAC.

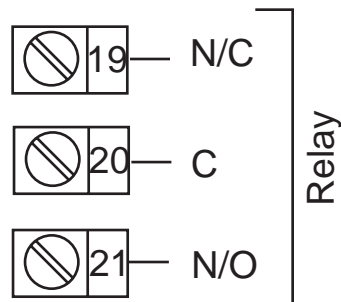

FIGURE 2-14

Relay Output 2

Connections are made to Output 2 relay as illustrated below. The contacts are rated at 2 amp resistive, 120/240 VAC.

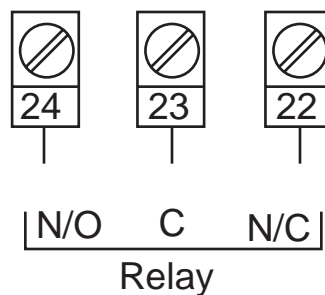

FIGURE 2-15

Relay Output 3

Connections are made to Output 3 relay as illustrated below. The contacts are rated at 2 amp resistive, 120/240 VAC.

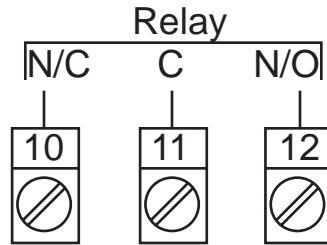
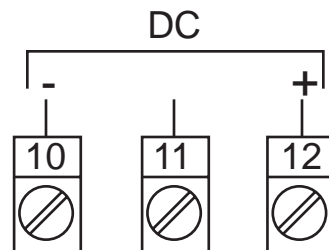

FIGURE 2-16

mADC Output 3 (Recorder Output Only)

Make connections for DC output 3 as illustrated below.



Operation 3.1

3.1.1 POWER UP PROCEDURE

Verify all electrical connections have been properly made before applying power to the instrument.

During power up, a self-test procedure is initiated during which all LED segments in the two front panel displays appear and all LED indicators are ON. When the self-test procedure is complete, the instrument reverts to normal operation.

Note: There is about a 3 second delay when power is first applied before the self-test begins.

3.1.2 KEYPAD OPERATION

RESET KEY

This key is used to:

1. Reset the limit condition after the process is within the limit.
2. Acknowledge the exceedence of the limit.
3. Confirm entry in Program mode.

SCROLL KEY

This key is used to:

1. Select a parameter to be viewed or adjusted.
2. Display enabled modes of operation.
3. Display a mode parameter value.
4. Advance display from a parameter value to the next parameter code.
5. With the DOWN key to view the current Hardware Definition Code setting.

UP KEY

This key is used to:

1. Increase the displayed parameter value.
2. Increase setpoint.
3. With the DOWN key to reset MAX/MIN HOLD and TIME EXCEED.

DOWN KEY

This key is used to:

1. Decrease the displayed parameter value.
2. Decrease setpoint.
3. With the SCROLL key to view the current Hardware Definition Code setting.
4. With the UP key to reset MAX/MIN HOLD and TIME EXCEED.

3.1.3 DISPLAYS

During normal operation, the upper display shows the value of the process variable. The lower display shows the setpoint value. If configured in Set-Up mode, the upper display can show the setpoint value and the lower display is blank. During configuration the upper display shows the parameter setting. The lower display shows the parameter code for the currently selected parameter.

3.1.3.1 DISPLAY SEQUENCE

During normal operating conditions, when the SCROLL key is pressed, "ULoc" will appear in the lower display and "0" in the upper display. To gain access to the Program and Set-Up modes, enter the correct code to "unlock" accessibility to these modes, then press the SCROLL key and "Ctrl" will appear in the display. Press the SCROLL key to the Program and/or Set-Up modes.

If any alarms have been programmed and the alarm(s) is/are energized, the display sequence is as follows: Press the SCROLL key and the Alarm Status Display, code "ALSt" appears in the lower display. Press the SCROLL key again and the upper display will then be showing the alarm status in the following format:

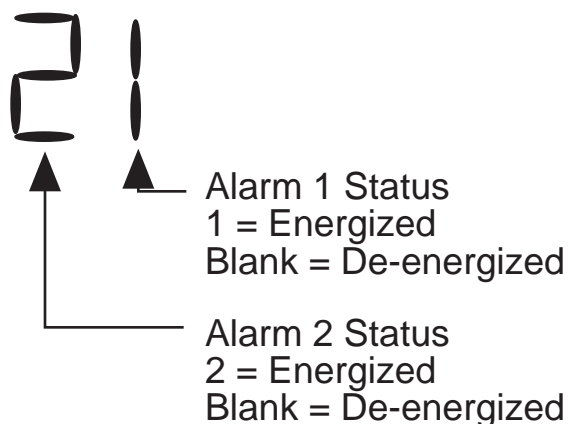

Pressing the SCROLL key and the display returns to its normal mode.

To gain access to the Program and/or Set-Up modes while an alarm is active, press the SCROLL key until "ALSt" appears in the lower display. With "ALSt" in the lower display, press the UP key and "ULoc" appears in the lower display and "0" in the upper display. Enter the correct code to unlock, then press the SCROLL key to the Program and/or Set-Up modes.

3.1.3.2 OVER-RANGE/UNDER-RANGE DISPLAY

If the process variable attains a value higher than the input scale maximum limit, the upper display will show:

The upper display shows the characters 'OH' in a large, stylized, seven-segment font. The 'O' is formed by the top, bottom, and right segments, while the 'H' is formed by the top, middle, and right segments.

If the process variable attains a value lower than the input scale minimum limit, the upper display will show:

The upper display shows the characters 'OL' in a large, stylized, seven-segment font. The 'O' is formed by the top, bottom, and right segments, while the 'L' is formed by the middle and right segments.

If a break is detected in the sensor circuit, the upper display will show:

The upper display shows the characters 'SnSr' in a large, stylized, seven-segment font. The 'S' is formed by the top, middle, and right segments, the 'n' is formed by the middle and right segments, and the 'r' is formed by the middle and right segments.

3.1.4 FRONT PANEL INDICATORS

OUT Indicates the status of the Limit Relay. When the indicator is **ON**, the relay is **de-energized** and when **Off** the relay is **energized**.

EXCEED This indicator is **On** when the process variable exceeds the limit setpoint (above for high limit, below for low limit). The indicator flashes if the exceedence is not acknowledged (i.e. Reset key is not pressed). The indicator is on steady if the exceedence has been acknowledged (i.e. Reset key has been pressed).
Note: This LED action will occur even if the annunciator output is NOT selected in configuration.

ALM This indicator shows an alarm condition.

S Indicates when in Set-Up mode.

3.1.5 SETPOINT ADJUSTMENT

To adjust the instrument setpoint, proceed as follows:

The setpoint is adjusted in the Set-Up mode. With "SEt" in the lower display, press the DOWN key, "SP" will appear in the lower display. With "SP" in the lower display, press the SCROLL key. The current setpoint value will appear in the upper display. To adjust the setpoint, press the UP or DOWN key as applicable.

Momentary depression will increment or decrement the setpoint by one unit in the least significant digit. If the key is held for longer than 1 second, the least significant digit will change at the rate of 25 units per second. If the key is held for longer than 10 seconds, the second least significant digit will change at the rate of 25 units per second. If the key is held for another 10 seconds, the third least significant digit will change at the rate of 25 units per second.

3.1.6 MAXIMUM/MINIMUM HOLD

A parameter is available that tracks and saves the maximum (high limit) or minimum (low limit) excursions of the process variable.

This parameter is a read only parameter and is viewed in the Set-Up mode, display code "HiHd" (maximum hold) and "LoHd" (minimum hold).

To reset this parameter, select the parameter and with the numeric value in the upper display, press and hold the UP and DOWN keys. After about 5 seconds, the upper display will indicate ---- for about another 2 seconds, then change to the current process value.

The value will be held through a supply power down/power up cycle.

3.1.7 TIME EXCEED

This parameter is available to measure the amount of time that the limit is exceeded.

This parameter is a read only parameter and is viewed in the Set-Up mode, display code "tLE".

The parameter will time in minutes and seconds from 0 to 99 minutes and 59 seconds. After this time the display will change automatically to indicate minutes and tens of seconds from 100.0 to 999.5. For times greater than 999.5 the display will be "[HH]".

The value viewed is the cumulative time that the instrument has been out of limit.

To reset this parameter, select the parameter and with the numeric value in the upper display, press and hold the UP and DOWN keys. After about 5 seconds, the upper display will indicate ---- for another 2 seconds, then change to 0.00.

The value will be held through a supply power down/power up cycle.

3.1.8 ANNUNCIATOR

An additional (optional) annunciator output is available. If selected in Program mode (either for USE2 or USE3) the annunciator output operates as follows:

If the limit is, or has been, exceeded AND the Reset key has NOT been pressed since the limit was exceeded, then the annunciator output will be active.

During the condition when the annunciator output is active, the EXCEED indicator will be flashing.

If the Reset key is pressed while the limit is exceeded, the EXCEED indicator will change to ON steady and the annunciator output is inactive. Subsequently, when the limit is not exceeded, the EXCEED indicator will go off.

3.1.9 REMOTE RESET (optional)

The Remote Reset option allows a dry contact closure to substitute for the front panel Reset switch. Operation is as follows:

If the option "rrES" (remote reset) is selected then:

A contact closure will simulate the action of the front panel reset switch.

A contact opening will have no effect.

If the external contacts are left closed, only ONE reset operation will occur. If the instrument subsequently goes into a state where reset is required again, the contacts must be opened and closed again. The front panel Reset switch can still be used to action a reset if required.

Configuration 3.2

All configurable parameters are provided in Tables 3-1 through 3-3 on the following pages. These tables illustrate the display sequence, parameter adjustment and factory setting for each step.

Depression of the SCROLL key will cycle the display (if alarms are not active) to the "Loc" feature where, after entering the correct code, the display cycles through all enabled modes as follows:

CONTROL ---- PROGRAM ---- SETUP
(Ctrl) (Prog) (SEt)

If a mode is not enabled it will be skipped over by the routine.

3.2.1 ENABLE MODE

The Enable mode provides a means of enabling or disabling access to the Program and Set-Up modes. Also found in the Enable mode is the current code value for the LOC/ULOC feature. The code may be modified here by using the UP/DOWN keys when the code is displayed.

If a mode has been disabled, then that mode will not be displayed or available to the user in the Control mode. See Table 3-1 (below) for the Enable mode procedure.

3.2.2 PROGRAM MODE

The Program mode is used to configure or re-configure the instrument. The input and output selections are made in the Program mode. All possible parameters are illustrated in Table 3-2 (page 28). Only those parameters that are applicable to the hardware options chosen will be displayed.

3.2.3 SET-UP MODE

The Set-Up mode is used to adjust the setpoint, make alarm settings and retransmit scaling needed for proper operation of the instrument. See Table 3-3 (page 30) for the Set-Up mode. Only those parameters that are applicable will be displayed.

TABLE 3-1 ENABLE MODE

To enter the Enable mode, press and hold the UP and DOWN keys. The display flashes for about 5 seconds, then returns to a normal display for about 5 more seconds, then displays "EnAb". Release the keys, the display should show "EPro". Pressing the DOWN key will display the Enable mode codes in the following sequence:

EPro - - ESEt - - Loc

(Continued on next page)

Pressing the SCROLL key will display the Enable mode codes with the upper display blank. The next depression of the SCROLL key will add the Enable code status (ON or OFF) to the upper display. With the Enable code status displayed, use the UP key to change the status to ON and the DOWN key to change the status to OFF.

To exit the Enable mode, press the UP key with the Enable code displayed in the lower display and the upper display blank.

STEP	DESCRIPTION	DISPLAY CODE	AVAILABLE SETTINGS	FACTORY SETTING
1	Program Mode	EPro	ON/OFF	ON
2	Set-Up Mode	ESEt	ON/OFF	ON
3	Lock	Loc	0 to 9999	10

TABLE 3-2 PROGRAM MODE

To enter the Program mode, press and release the SCROLL key until "Prog" is displayed. Use the DOWN key to enter the Program mode. Depress and release the SCROLL key to sequence through the parameters and their values, alternately showing the parameter code in the lower display with the upper display blank, then the parameter code with the parameter value displayed. Use the UP and DOWN keys to adjust the parameter values. After adjusting a parameter, the upper display will flash, indicating that the new setting has yet to be confirmed. When the setting is as required, it may be confirmed by pressing the RESET key and the upper display stops flashing. After confirming a change, press the SCROLL key to proceed to the next parameter. Use the DOWN key to advance to the next parameter when a parameter code is showing in the lower display and the upper display is blank.

To exit the Program mode, press the UP key whenever a parameter code is displayed in the lower display and the upper display is blank.

DEFAULT PARAMETER INDICATION

If a parameter value, such as Input Select, was changed while in the Program mode, when returning to the Control mode, a decimal point after each digit will be lit. This display indicates all Set-Up mode parameters have been set to their default condition. To clear this condition, enter the Set-Up mode and make a parameter value change and review each parameter for its proper setting.

STEP	DESCRIPTION	DISPLAY CODE	AVAILABLE SETTINGS	FACTORY SETTING
1	Input Select	inPS	See App. D*	1420
2	Limit Action	ACt	Hi or Lo	Hi
3	Alarm 1 Type	ALA1	P_hi =Proc High nonE=No Alarm P_Lo=Proc Low	P_hi
4	Alarm 2 Type	ALA2	Same selection as ALA1	P_hi
5	Output 2 Usage	USE2	A1_d =Alm 1 Direct LA_r =Annunc. Reverse LA_d=Annunc. Direct Ad_r =Rev Logic AND Ad_d=Dir Logic AND Or_r =Rev Logic OR Or_d =Dir Logic OR A2_r =Alm 2 Reverse A2_d=Alm 2 Direct A1_r=Alm 1 Reverse	A1_d
6	Output 3 Usage	USE3	A1_d=Alm 1 Direct rEcP=Rcdr Out P.V rEcS=Rcdr Out S.P. LA_r=Annunc. Reverse LA_d=Annunc. Direct Ad_r=Reverse Logic AND Ad_d=Direct Logic AND Or_r=Rev Logic OR Or_d=Dir Logic OR A2_r=Alm 2 Rev A2_d=Alm 2 Dir A1_r=Alm 1 Rev	A1_d
7	Com Bit Rate	CbS	1200, 2400, 4800, 9600	4800

8	Com Address	CAd	1 - 32	1
9	CJC Enable	CJC	EnAb diSA	EnAb

* The Hardware Definition Code and input jumper configuration may need to be changed. See Appendix B and C.

TABLE 3-3 SET-UP MODE

To enter the Set-Up mode, press and release the SCROLL key until "SET" is displayed. Use the DOWN key to enter the Set-Up mode. The "S" LED should be lit. Depress and release the SCROLL key to sequence through the parameters and their values, alternately showing the parameter code in the lower display with the upper display blank, then the parameter code with the parameter value displayed. Use the UP and DOWN keys to adjust the parameter values. After adjusting a parameter, depress the SCROLL key to proceed to the next parameter. Use the DOWN key to advance to the next parameter when a parameter code is showing in the lower display and the upper display is blank.

To exit the Set-Up mode, press the UP key whenever a parameter code is displayed in the lower display and the upper display is blank.

STEP	DESCRIPTION	DISPLAY CODE	AVAILABLE SETTINGS	FACTORY SETTING
1	Limit Setpoint	SP	± Span	150**
2	Maximum Hold	HiHd	Read Only	
3	Minimum Hold	LoHd	Read Only	
4	Time Exceeded	tLE	Read Only	
5	Input Filter	Filt	0.0 to 100.0 seconds in .5 second increments	2.0
6	Hysteresis Limit Output	HySt	0 to 10% of span, expressed in units	1

STEP	DESCRIPTION	DISPLAY CODE	AVAILABLE SETTINGS	FACTORY SETTING
7	Process Out Upper	Pou	-1999 to 9999	Span max.
8	Process Out Lower	PoL	-1999 to 9999	Span min.
9	Process High Alarm 1	PHA1	± Span	Span Max.
10	Process Low Alarm 1	PLA1	± Span	Span Min.
11	Process High Alarm 2	PHA2	± Span	Span Max.
12	Process Low Alarm 2	PLA2	± Span	Span Min.
13	Decimal Position	dPoS	0,1,2,3 (Linear Inputs)	0
14	Engineering Units Upper	Euu	-1999 to 9999	1000
15	Engineering Units Lower	EuL	-1999 to 9999	0
16	Comm. Enable	CCon	0=Disable 1=Enable	1
17	Display Enable	diSP	0=Disable 1=Enable	1

** Setpoint Default - 150 for linear and F ranges, 65.5 for C ranges except B thermocouple which is 212F and 100C.

Appendix A

Glossary of Terms

Input Filter Time Constant

This parameter is used to filter out any extraneous impulses on the process variable. This filtered PV is used for all PV-dependent functions (limit, alarm, etc). The time constant is adjustable from 0.0 seconds (off) to 100.0 seconds, in 0.5 second increments. Default value is 2.0 seconds. Display code is FiLt.

Hysteresis

This parameter is a switching differential on the non-exceeded side of limit and is adjustable within the range of 0 to 10.0%, expressed in units. Default value is 1. Display code is HySt.

Process Output Upper Value

This parameter defines the value of the retransmitted output (process variable or setpoint, whichever is applicable) at its maximum value; for example, for a 0-5V output, this value corresponds to 5V. It may be adjusted within the range -1999 to 9999. The decimal position is always the same as that for the process variable input. Default value is Input Range Maximum. Display code is Pou.

Note: If this parameter is set to a value less than that for the Process Output Lower Value, the relationship between the process variable/setpoint value and the retransmission output is reversed.

Process Output Lower Value

This parameter defines the value of the retransmitted output (process variable or setpoint, whichever is applicable) at its minimum value; for example, for a 0-5V output, this value corresponds to 0 V. It may be adjusted within the range -1999 to 9999. The decimal position is always the same as that for the process variable input. Default value is Input Range Minimum. Display code is PoL.

Note: If this parameter is set to a value greater than that for the Process Output Upper Value, the relationship between the process variable/setpoint value and the retransmission output is reversed.

Process High Alarm 1 Value

This parameter, applicable only when Alarm 1 is selected to be a Process High alarm, defines the process variable value at or above which Alarm 1 will be active. Its value may be adjusted between Input Range Maximum and Input Range Minimum. Its default value is Input Range Maximum. Display code is PHA1.

Process Low Alarm 1 Value

This parameter, applicable only when Alarm 1 is selected to be a Process Low alarm, defines the process variable value at or below which Alarm 1 will be active. Its value may be adjusted between Input Range Maximum and Input Range Minimum. Its default value is Input Range Minimum. Display code is PLA1.

Process High Alarm 2 Value

This parameter, applicable only when Alarm 2 is selected to be a Process High Alarm, defines the process variable value at or above which Alarm 2 will be active. Its value may be adjusted between Input Range Maximum and Input Range Minimum. Its default value is Input Range Maximum. Display code is PHA2.

Process Low Alarm 2 Value

This parameter, applicable only when Alarm 2 is selected to be a Process Low Alarm, defines the process variable value at or below which Alarm 2 will be active. Its value may be adjusted between Input Range Maximum and Input Range Minimum. Its default value is Input Range Minimum. Display code is PLA2.

Logical Combination of Alarms

Two alarms may be combined logically to create an AND/OR situation. They may be configured for Reverse-acting or Direct-acting. Either Output 2 or Output 3 may be assigned as Logical Outputs.

Example:

Logical OR of Alarm 1 with Alarm 2

Direct-Acting

AL-1 OFF, AL-2 OFF: Relay OFF
AL-1 ON, AL-2 OFF: Relay ON
AL-1 OFF, AL-2 ON: Relay ON
AL-1 ON, AL-2 ON: Relay ON

Reverse-Acting

AL-1 OFF, AL-2 OFF: Relay ON
AL-1 ON, AL-2 OFF: Relay OFF
AL-1 OFF, AL-2 ON: Relay OFF
AL-1 ON, AL-2 ON: Relay OFF

(Continued on next page)

Logical AND of Alarm 1 with Alarm 2

Direct-Acting

AL-1 OFF, AL-2 OFF: Relay OFF
AL-1 ON, AL-2 OFF: Relay OFF
AL-1 OFF, AL-2 ON: Relay OFF
AL-1 ON, AL-2 ON: Relay ON

Reverse-Acting

AL-1 OFF, AL-2 OFF: Relay ON
AL-1 ON, AL-2 OFF: Relay ON
AL-1 OFF, AL-2 ON: Relay ON
AL-1 ON, AL-2 ON: Relay OFF

Decimal Point

This parameter, applicable only if a linear input is specified, defines the position of the decimal point in values for the process variable, setpoint, alarm levels and retransmission outputs as follows:

Value	Decimal Point Position
0	XXXX
1	XXX.X
2	XX.XX
3	X.XXX

The default value is 0. Display code is dPoS.

Engineering Units Upper

This parameter, applicable only if a linear input is specified, defines the scaled input value when the process variable input is at its maximum value. It is adjustable between -1999 to 9999. The default value is 1000. This parameter can be set to a value less than (but not equal to) Engineering Units Lower, in which case the sense of the input is reversed. Display code is Euu.

Engineering Units Lower

This parameter, applicable only if a linear input is specified, defines the scaled input value when the process variable input is at its minimum value. It is adjustable between -1999 and 9999. The default value is 0. This parameter can be set to a value greater than (but not equal to) Engineering Units Upper, in which case the sense of the input is reversed. Display code is EuL.

Maximum Hold

This parameter tracks and saves the maximum excursions of the process variable, applicable to a High Limit only. This is a Read Only parameter. Display code is HiHd.

Minimum Hold

This parameter tracks and saves the minimum excursions of the process variable, applicable to a Low Limit only. This is a Read Only parameter. Display code is LoHd.

Time Exceeded

This parameter measures and saves the amount of time that the limit is exceeded. The time is measured and displayed in minutes and seconds from 0 to 99 minutes and 59 seconds. After this time the display will change automatically to indicate minutes and tens of seconds from 100.0 to 999.5. For times greater than 999.5, the display "[HH]" will be shown. This is a Read Only parameter. Display code is tLE.

Appendix B

Exploded View & Board Layout

FIGURE B-1 EXPLODED VIEW

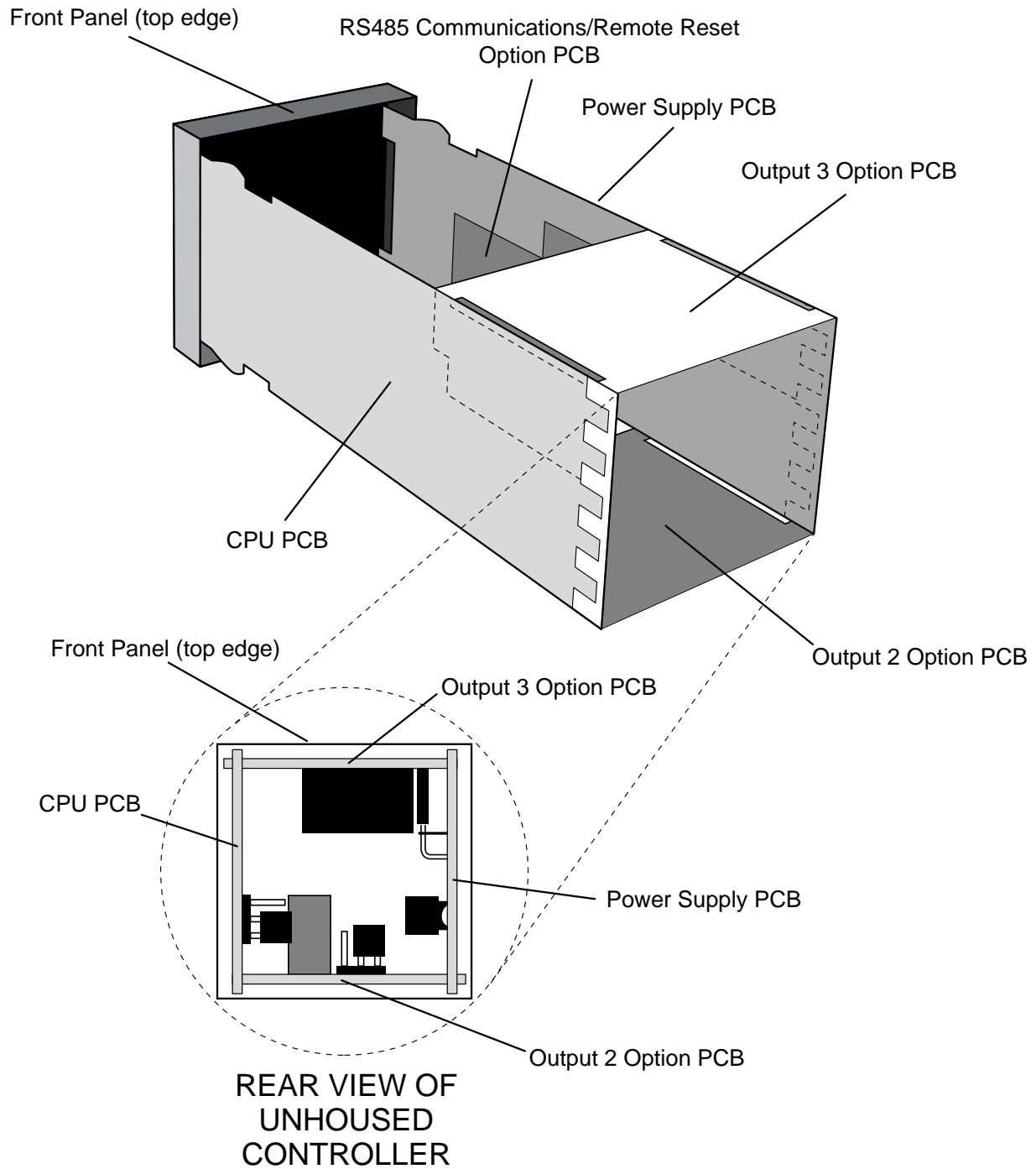
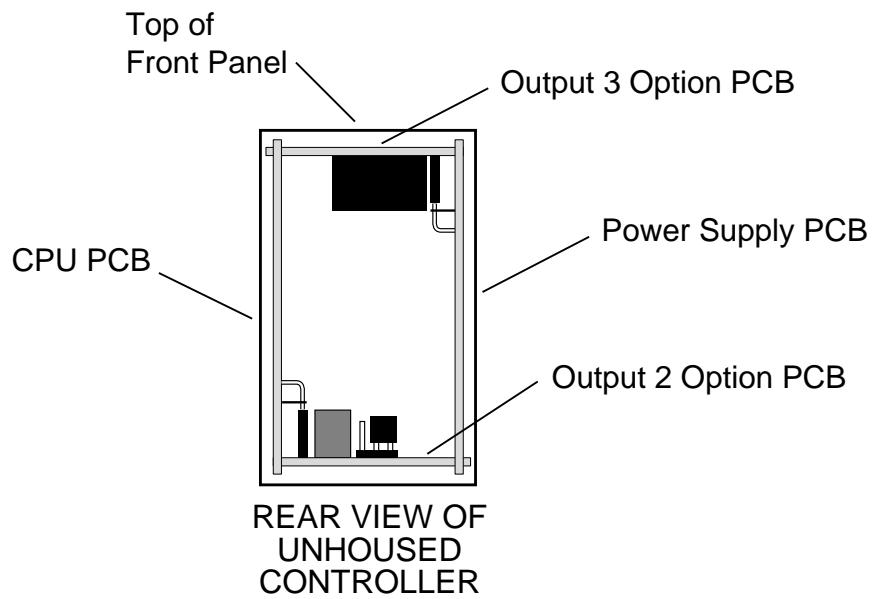
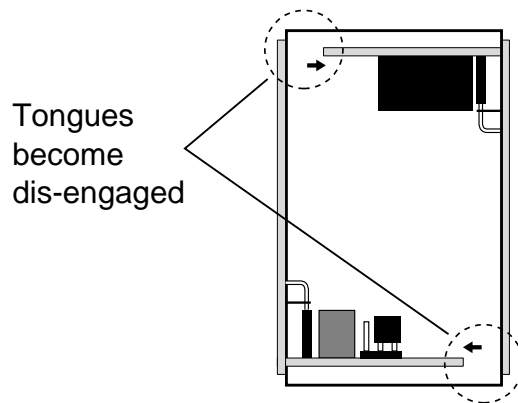

FIGURE B-2 OUTPUT 2/OUTPUT 3 REMOVAL

A



B



C

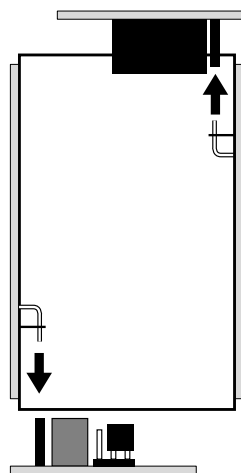
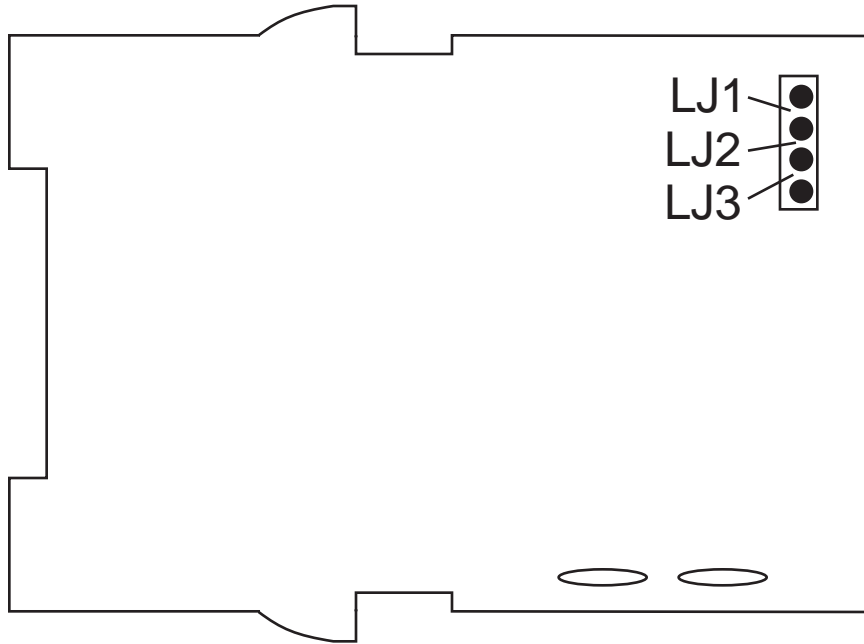

FIGURE B-3 CPU PWA



Input Conditioning Jumper

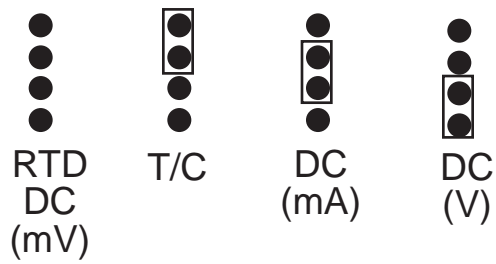
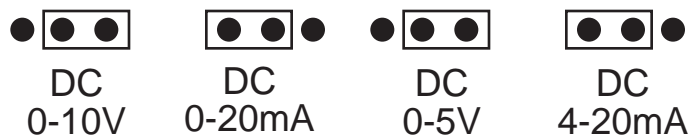
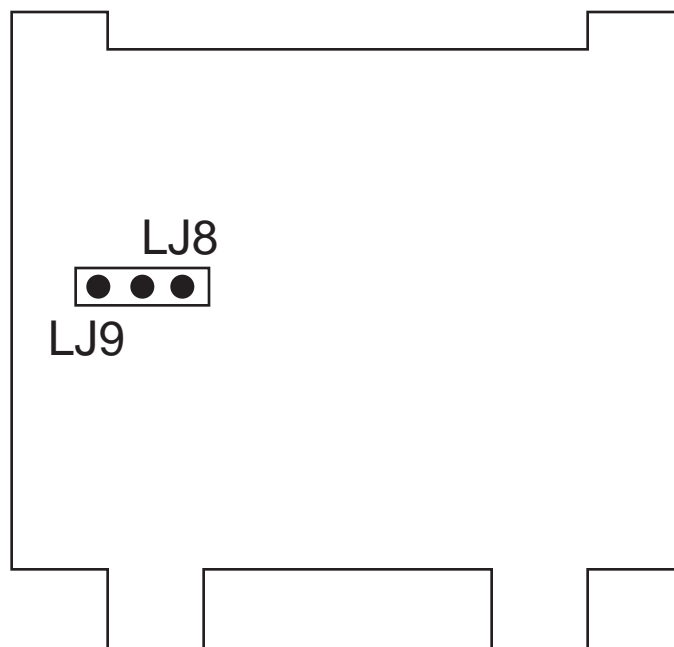

FIGURE B-4 OPTION PWA DC OUTPUT 3



Appendix C

Hardware Definition Code

The Hardware Definition Code is used to represent the hardware installed (input type, Output 2 type, Output 3 type and Options); this must be compatible with the hardware actually installed. It can be accessed, with the instrument in Program mode, by simultaneously depressing the DOWN and SCROLL keys while the parameter is displayed in the lower display and the value in the upper display. The displays will show "XXXX" (where X represents any number) in the upper display and "dEFn" in the lower display, where:

the first (left-most) digit is input type:

- 1=RTD/Linear mV
- 2=Thermocouple
- 3=Linear DC mA
- 4=Linear DC V

the second digit is Output 1 type:

- 1=Relay (Limit Only)

the third digit is Output 2 type:

- 0=Output 2 not installed
- 1=Relay (Alarm Only)

the fourth digit is Output 3 type:

- 0=Output 3 not installed
- 1=Relay (Alarm only)
- 3=DC 0-10V (retransmit only)
- 4=DC 0-20mA (retransmit only)
- 5=DC 0-5V (retransmit only)
- 7=DC 4-20mA (retransmit only)

The displayed code may be incremented/decremented using the UP/DOWN keys as required. The maximum setting available is 4117. For example, the code for a thermocouple input, Relay Output 1 and Relay Output 3 would be 2101. When the code is first altered, the code display will flash, until the desired value is displayed and confirmed by pressing the RESET key.

While the Hardware Definition Code is displayed, depressing the SCROLL key will cause the display to change to:

nonE or r485 or rrES
OPtn OPtn OPtn

Where "nonE" indicates the absence of the communications option and the remote reset option. "r485" indicates the presence of the communications option. "rrES" indicates the presence of the remote reset option.

NOTE: It is essential that this code is changed whenever there is a change to the instrument's hardware configuration (change of input type, alarm/retransmit output etc.). The instrument's software depends upon this code to ensure that the instrument operates correctly.

To exit from the Hardware Definition Code display, depress the DOWN and SCROLL keys simultaneously.

Appendix D

Input Range Codes

The input ranges available (selectable via the front panel) are:

For Thermocouple Inputs

TYPE	INPUT RANGE	DISPLAYED CODE	TYPE	INPUT RANGE	DISPLAYED CODE
R	0 - 1650°C	1127	K	-200 - 760°C	6726
R	32 - 3002°F	1128	K	-328 - 1399°F	6727
S	0 - 1649°C	1227	K	-200 - 1373°C	6709
S	32 - 3000°F	1228	K	-328 - 2503°F	6710
J	0.0 - 205.4°C	1415	L	0.0 - 205.7°C	1815
J	32.0 - 401.7°F	1416	L	32.0 - 402.3°F	1816
J	0 - 450°C	1417	L	0 - 450°C	1817
J	32 - 842°F	1418	L	32 - 842°F	1818
J	0 - 761°C	1419	L	0 - 762°C	1819
J	32 - 1402°F	1420*	L	32 - 1404°F	1820
T	-200 - 262°C	1525	B	100 - 1824°C	1938
T	-328 - 504°F	1526	B	212 - 3315°F	1934
T	0.0 - 260.6°C	1541	N	0 - 1399°C	5371
T	32.0 - 501.1°F	1542	N	32 - 2550°F	5324

*Factory Default

For RTD Inputs

Note: Input conditioning jumper JU1 needs to be changed, see Appendix B.

INPUT RANGE	DISPLAYED CODE	INPUT RANGE	DISPLAYED CODE
0 - 800°C	7220	0.0 - 100.9°C	2295
32 - 1471°F	7221	32.0 - 213.6°F	2296
32 - 572°F	2229	-200 - 206°C	2297
-101.0 - 100.0°C	2230	-328 - 403°F	2298
-149.8 - 212.0°F	2231	-100.9 - 537.3°C	7222
0 - 300°C	2251	-149.7 - 999.1°F	7223

For DC Inputs

Note: Input conditioning jumper JU1 needs to be changed, see Appendix B. Also, the Hardware Definition Code for the input type must also be changed, see Appendix C.

INPUT RANGE	DISPLAYED CODE	INPUT RANGE	DISPLAYED CODE
0 - 20mA	3413	0 - 5V	4445
4 - 20mA	3414	1 - 5V	4434
0 - 50mV	4443	0 - 10V	4446
10 - 50mV	4499	2 - 10V	4450

Appendix E

Specifications

INPUT SPECIFICATIONS

General

Input Sample Rate:	Four per second
Input Resolution:	14 bits approximately
Input Impedance:	Greater than 100M ohm resistive (except for DC mA and V inputs)
Isolation:	Universal input isolated from all outputs except SSR at 240 VAC.

Thermocouple

Types:	R, S, J, T, K, L, B and N
Sensor Break Protection:	Break detected within 2 seconds. Limit Relay OFF, alarms operate as if the process variable has gone over-range.

RTD and DC mV

Type and Connection:	Three-wire Pt100 (.00385 ohm/ohm/C)
Lead Compensation:	Automatic
Sensor Break Protection:	Break detected within 2 seconds. Limit Relay OFF, alarms operate as if the process variable has gone under-range.

DC mA and DC V

Scale Range Maximum:	-1999 to 9999
Scale Range Minimum:	-1999 to 9999
Minimum Span:	1 display LSD
Sensor Break Protection:	Applicable to 4-20mA, 1-5V, and 2-10V ranges only. Break detected within 2 seconds. Limit Relay OFF, alarms operate as if the process variable has gone under-range.

Remote Reset

Type:	Voltage free contact, closure required to reset.
-------	--

Output Specifications

Limit Switch Output 1

Type: Relay
Contact Type: Single Pole/Double Throw (SPDT)
Rating: 5A resistive at 120/240V AC
Lifetime: > 100,000 operations at rated voltage/current
Isolation: Inherent

OUTPUT 2 (Alarm or Annunciator)

Type: Relay
Contact Type: Single Pole/Double Throw (SPDT)
Rating: 2A resistive at 120/240V AC
Lifetime: > 500,000 operations at rated voltage/current
Isolation: Inherent

OUTPUT 3 (Alarm, Annunciator, or Retransmit)

Type: Relay or DC linear (retransmit only)

Relay

Contact Type: Single Pole/Double Throw (SPDT)
Rating: 2A resistive at 120/240V AC
Lifetime: > 500,000 operations at rated voltage/current
Isolation: Inherent

Retransmit

Resolution: Eight bits in 250ms (10 bits in 1000 ms typical, >10 bits in >1000 ms typical).

Update Rate: 4/sec.

Ranges: 0-20mA, 4-20mA, 0-10V, and 0-5V

Load Impedance: 0-20mA: 500 ohm maximum
4-20mA: 500 ohm maximum
0-10V: 500 ohm minimum
0-5V: 500 ohm minimum

Isolation: Isolated from all other inputs and outputs.

Alarms

Maximum Number: Two "soft" alarms
Maximum # Outputs: Up to 2 outputs can be used for alarm purposes
Comb. of Alarms: Logical ORing or ANDing of alarms to an individual hardware output is available.

PERFORMANCE

Reference Conditions

Ambient Temperature: $20^{\circ}\text{C} \pm 2^{\circ}\text{C}$
Relative Humidity: 60-70%
Supply Voltage: 90-264VAC 50Hz $\pm 1\%$
Source Resistance: <10 ohm for T/C input
Lead Resistance: <0.1 ohm/lead balanced (Pt100)
Common Mode
Rejection: $>120\text{dB}$ at 50/60Hz giving negligible effect at up to 264V 50/60Hz

Series Mode

Rejection: $>500\%$ of span (at 50/60Hz) causes negligible effect

Operating Conditions

Ambient Temperature: 0 to 55°C
Ambient Temperature
Storage: -20 to 80°C
Temperature Stability: 0.01% of span/ $^{\circ}\text{C}$ change in ambient
Relative Humidity: 20 to 95% non-condensing
Supply Voltage: 90-264 VAC 50/60Hz
Source Resistance: 1000 ohm maximum (thermocouple)
Lead Resistance: 50 ohm/lead maximum balanced (Pt100)

Measurement Accuracy

DC Linear Inputs: $\pm 0.25\%$ of span ± 1 LSD

RTD/

Thermocouple Inputs: $\pm 0.25\%$ of span ± 1 LSD

Note: Reduced performance with Type B T/C between $100-600^{\circ}\text{C}$ ($212-1112^{\circ}\text{F}$)

Linearization: Better than $\pm 0.2^{\circ}\text{C}$ any point, any 0.1°C range ($\pm 0.05^{\circ}\text{C}$ typical). Better than $\pm 0.5^{\circ}\text{C}$ any point, any 1°C range.

Cold Junction
Compensation: Better than $\pm 0.7^{\circ}\text{C}$

PHYSICAL

Display Character

Height: Top: .36 inches, Bottom: .28 inches

Dimensions: 1/8 DIN front panel (96mm x 96mm) 4.33 inches
deep

Mounting: Plug-in with panel mounting fixing strap.
Panel cut-out 96mm x 96mm.

Terminals: Screw type (combination head)

Power Consumption: Approximately 4 watts

Front Panel Sealing: IP65/NEMA 4

Weight: 8 ounces maximum

Approvals: FM pending

Appendix F

Order Matrix

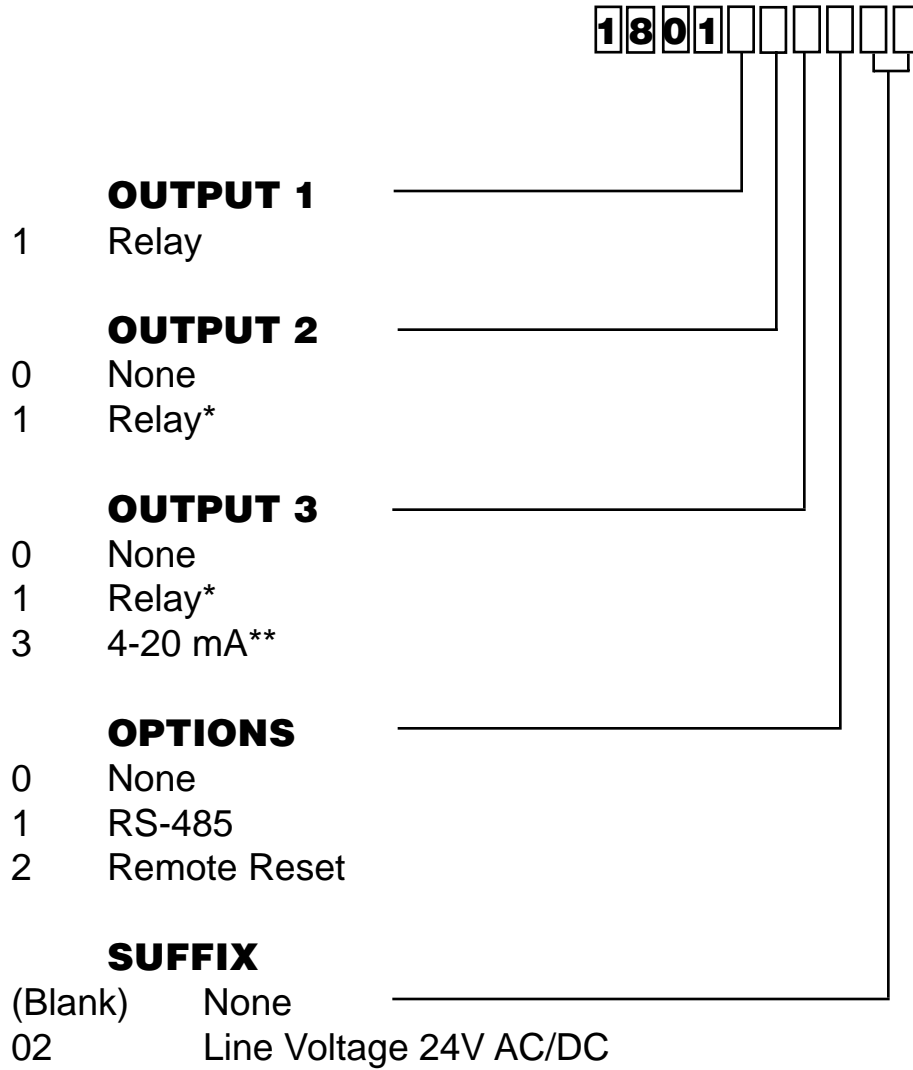

*For alarm output only
 ** For retransmission only

Appendix G

Software Reference Sheet

HDW DEF	
OPTION	

Program	Mode
inPS	
ACt	
ALA1	
ALA2	
USE2	
USE3	
CbS	
CAd	
CJC	

Enable	Mode	
ENAB	ON	OFF
EPro		
ESEt		
Loc	0/9999	

(continued on next page)

Set-Up	Mode
SP	
HiHd	
LoHd	
tLe	
Filt	
HySt	
Pou	
PoL	
PHA1	
PLA1	
PHA2	
PLA2	
dPoS	
Euu	
EuL	
CCon	
diSP	

